

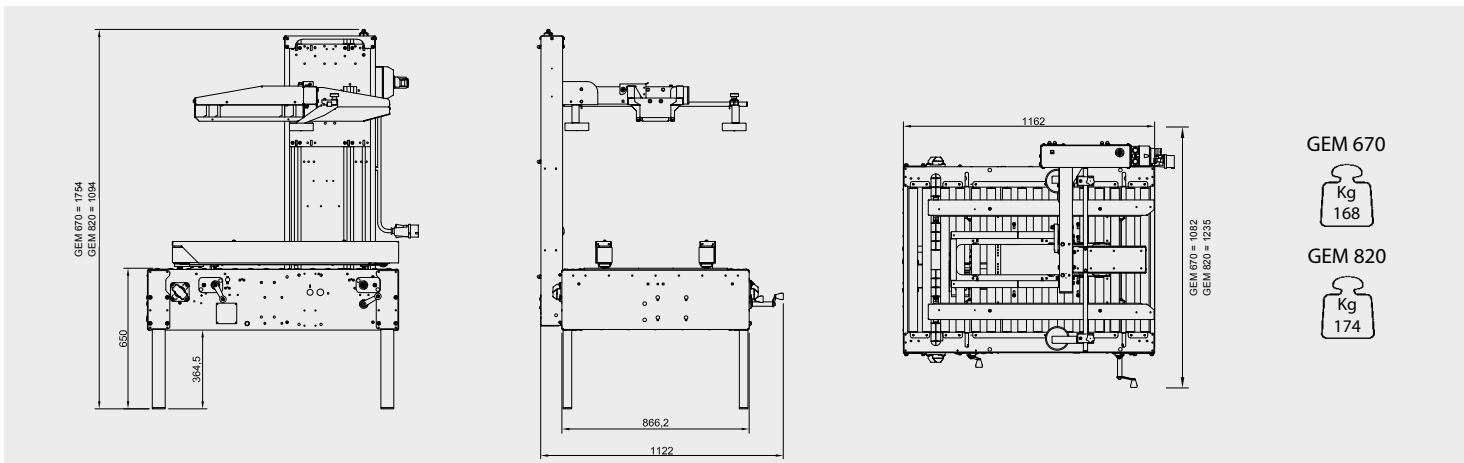

GEM 670 / 820

- NASTRATRICE SEMIAUTOMATICA PER SCATOLE A FORMATO FISSO
- SEMIAUTOMATIC TAPING MACHINE FOR FIXED-FORMAT BOXES
- MACHINE SEMI-AUTOMATIQUE POUR BOITE MONO - FORMAT
- HALBAUTOMATISCHE KLEBEMASCHINE FÜR SCHACHTELN MIT GLEICHEN FORMAT
- PRECINTADORA SEMIAUTOMATICA PARA CAJAS DE FORMATO FIJO



GEM 670



GEM 820

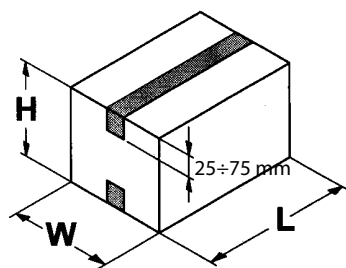

GEM 670

	MIN	MAX
L	150 mm	∞
W	100 mm	670 mm
H	120 mm	670 mm

GEM 820

	MIN	MAX
L	150 mm	∞
W	100 mm	820 mm
H	120 mm	820 mm

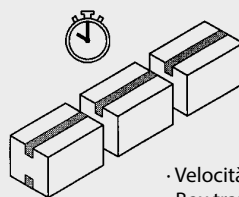

- Produzione media: 1000 scatole/ora
- Production moyenne: 1000 boîtes/heure
- Producción promedio: 1000 cajas/hora
- Average production: 1000 boxes/hour
- Durchschnittliche Produktion: 1000 Kartons/Std

- Velocità di trasferimento scatola: ~22 mt/min
- Box transfer speed: ~22 mt/min
- Vitesse de transfert de la boîte: ~22 mt/min
- Transportgeschwindigkeit der Kartons: ~22 mt/min
- Velocidad de desplazamiento caja: ~22 mt/min

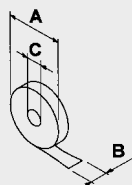

A	MAX 360 mm
B	25 ÷ 75 mm
C	76 mm

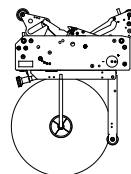

- Teste Nastranti: T21 - T21,5
- Taping Heads: T22 - T23
- Têtes de pose: T32 - T33
- Klebeköpfe: T32 - T33
- Cabezal de precinto:

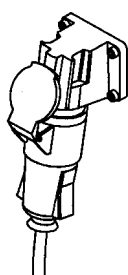

- Alimentazione: 3 PH + PE
- Power supply: 3 PH + PE
- Alimentation: 3 PH + PE
- Speisung: 3 PH + PE
- Alimentacion: 3 PH + PE
- *** Others on demand

- Potenza installata: 0,25 kW
- Installed power: 0,25 kW
- Puissance installée: 0,25 kW
- Eingerichtete Leistung: 0,25 kW
- Potencia instalada: 0,25 kW
- Protezione elettrica: IP54
- Electrical protection: IP54
- Protection électrique: IP54
- Stromschutz: IP54
- Protección eléctrica: IP54

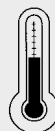

- Temperatura di utilizzo: MAX
- Temperature of use: +35°C/95°F
- Température d'utilisation: MIN
- Betriebstemperatur: +5°C/41°F
- Temperatura de uso:

OPTIONALS

- Ruote con freno con altezza regolabile
- Chiusura vano inferiore
- Bancaletto ingresso / uscita scatola
- Stazione di riempimento in ingresso - SRF
- Kit chiuditrefalde
- Doppi rulli pressatori per maggiore stabilità scatola
- Cinghie di trascinamento ribassate / allungate
- Bancaletto pneumatico per centratura scatola

OPTIONALS

- Caster wheels
- Bottom cover van
- Infeed & outfeed conveyors
- Filling station SRF model in infeed
- Three flaps closing device
- Double presser rollers for box stability
- Driving belts H30/H70 longer driving belts
- Pneumatic centering device in infeed

OPTIONAL

- Roues avec frein et hauteur réglable
- Fermeture sur la partie inférieure
- Convoyeur bancaletto en entrée et sortie
- Station de remplissage à l'entrée SRF
- Kit de fermeture des 3 rabats
- Double rouleaux presseurs pour garantir une meilleure stabilité de la caisse
- Courroies d'entraînement des caisses rabaisées ou allongées
- Centreur pneumatique en entrée

OPTIONAL

- Höheneinstellbare Räder mit Feststellbremse
- Abdeckung für Schacht des unteren Klebeaggregates
- Einlauf-/Auslauf Rollentisch
- Befüllstation am Einlauf - SRF
- Kit 3-Laschen-Faltung
- Doppelte Andruckrollen für verbesserte Stabilität des Kartons
- Niedrige/verlängerte Transportriemen
- Pneumatischer Rollentisch mit Zentrierung

OPTIONAL

- Ruedas con frenos con altura ajustable
- Cierre del compartimento inferior
- Mesa de entrada / salida caja
- Estación de servicio en entrada - SRF
- Kit de cierre
- Rodillos de doble presión para mayor caja de estabilidad
- Cinturones de arrastre bajado / estirado
- Banco neumático para cuadro de centrado

Distributed by

Idépack Verpakingsmachines B.V.
Zeilmaker 8
NL-3861 SM Nijkerk
Tel. +31(0)33-299 00 08
www.idepack.com info@idepack.com



COMARME S.r.l. a socio unico

sede operativa (factory)

Quartiere Mirabella snc, 20081 Abbiategrasso (MI) - ITALY

Tel. +39 02 9422002 - Fax +39 02 9422096

e-mail: info@comarmesrl.com - website: www.comarmesrl.com